

# "Pool-Pro"® Type SP Butterfly Valve

## Parts Identification

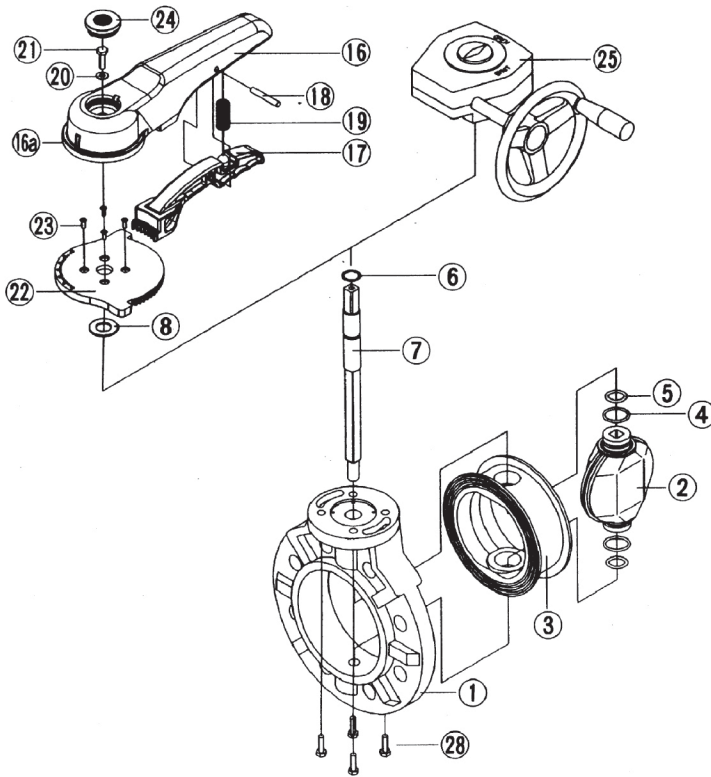

**Caution: The "Pool-Pro"® Type SP Valve is intended and warranted for swimming pool applications only**

No.	DESCRIPTION	No.	DESCRIPTION
1	Body	17	Handle lever
2	Disc	18	Pin
3	Seat	19	Spring
4	O-ring (A)	20	Washer (A)
5	O-ring (B)	21	Bolt (B)
6	O-ring (C)	22	Locking plate
7	Stem	23	Screw (B)
8	Stem holder (A)	24	Cap (A)
16	Blue Handle (A)	25	Gear box
16a	Inserted metal of handle	28	Bolt (C)

## Installation Procedure

### Procedure

- 1) Install the valve between flanges with the valve slightly open. (Refer to Fig. 1)
- 2) Insert bolts, nuts and washers and tighten the bolts and nuts temporarily by hand.
- 3) Open the valve fully to check for pipe interference before fully tightening the bolts.

The parallelism and axial misalignment of the flange surface should be under the values shown in the following table ( Refer to Table 1) to prevent damage to the valve.

Table 1 Unit: inch

Nominal Size	Axial misalignment	Parallelism (a - b)
1 1/2" - 3"	0.04	0.03
4" - 6"	0.04	0.04
8" - 12"	0.06	0.04

(Refer to Fig. 2)

- 4) Tighten the bolts and nuts gradually with a torque wrench to the specified torque level in a diagonal manner. (Refer to Table 2 and Figure 3)

Table 2 Recommended torque value Unit: foot-lbs

Nominal Size	Torque value	Nominal Size	Torque value
1 1/2"	14	8" - 10"	40
2" - 2 1/2"	16	12"	43
3" - 4"	22		
6"	32		

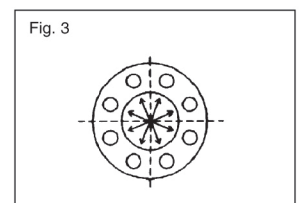
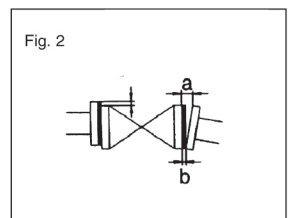
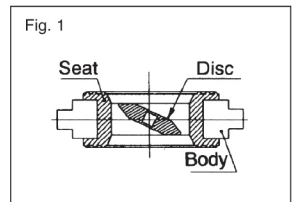

### Installation Procedure for Handle

Install the handle on the stem. Set the direction of handle to correspond with the indication line at the top of stem.

- 1) Secure the handle at the top of stem with the enclosed bolt and washer by using a socket wrench.
- 2) Set the cap on top of the handle and gently strike it with a rubber or plastic hammer, until it is seated.

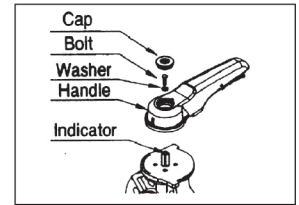

Nominal Size	1 1/2" – 4"	6" – 8"
Bolt Size	M6 x 15L	M8 x 15L
Socket Size	10 MM	13 MM

### Removal Procedure

- 1) To remove the cap, insert a screwdriver into the indentation, then push down and pry out.
- 2) Remove the bolt and washer by using a socket wrench, then remove the handle.

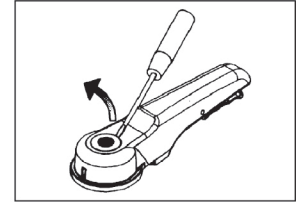

### Adjustment Procedure for Travel Stop Gear Type

The adjustments for full-opened and full-closed position are preset at the factory. If adjustment is required refer to the following procedure:

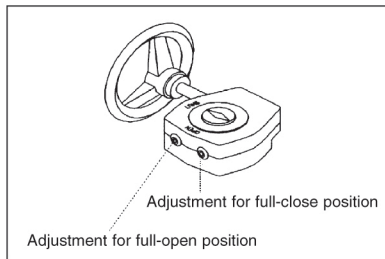

#### Adjustment for Full-Closed (Full-Opened) Position

- 1) Remove the protective rubber caps
- 2) Loosen the stop hex-bolt with an allen wrench.
- 3) Adjust the disc of valve to the required position.
- 4) Tighten the stop hex-bolts.
- 5) Replace the protective rubber caps.

### Working Pressure Vs. Temperature

PSI, WATER, NON-SHOCK

Body	PVC
Disc	PVC
Nominal Size (inches)	30° F 120° F
1 1/2" - 3"	150
4" - 6"	150
8" - 10"	150
12"	100

### Operating procedure

- √ Open and close the valve by turning handle slowly. Turn clockwise to close and counterclockwise to open.
- √ Lever type, the direction of handle is same as the disc.
  - For the full-closed position, the handle is perpendicular to the piping system.
  - For the full-opened position, the handle is parallel to the piping system.
- √ Gear type, the indicator shows the position of the disc on the top of gear box.
  - For the full-closed position, the indication shows Shut.
  - For the full-opened position, the indication shows Open.

### General Operating Instructions

- √ Operate the valve within the Pressure Vs Temperature range. (The valve can be damaged by operating beyond the allowable range.)
- √ Select a valve material that is compatible with the media, refer to "CHEMICAL RESISTANCE ON ASAHI AV VALVE". (Some chemicals may damage incompatible valve materials.)
- √ Do not step on the valve or apply excessive weight on the valve. (It can be damaged.)
- √ Allow sufficient space for maintenance and inspection.
- √ Keep the valve away from excessive heat or fire. (It can be deformed or destroyed.)
- √ Make sure to consult a waste treatment dealer to dispose of the valves. (Poisonous gas is generated when the valve is burned improperly.)

**Caution: Do not change or replace valve parts under line pressure.**  
An O&M Manual is available upon request.



655 Andover St. P.O. Box 1108, Lawrence, MA 01843 - Tel: (781) 321-5409 - Fax (978) 685-3010